











30 010 662



- 126mm projection
- fixed spout
- circular, air-enriched flow
- hole diameter 35 mm
- rosette Ø 60 mm
- max. flow 5.7 l/min
- lead-free
- This product can help a building meet the requirements of Green Building Rating Systems, e.g. LEED®, BREEAM®, DGNB

	Chrome	30 010 662-00
	Brushed Platinum	30 010 662-06
	Dark Chrome	30 010 662-19
	Light Gold	30 010 662-26
	Brushed Light Gold	30 010 662-27
	Matte Black	30 010 662-33
	Brushed Bronze	30 010 662-42
	Brushed Champagne (22kt Gold)	30 010 662-46
	Champagne (22kt Gold)	30 010 662-47
	Brushed Chrome	30 010 662-93
	Brushed Dark Platinum	30 010 662-99

**Recommended miscellaneous**

- Concealed wall elbow -** 35 085 970 90
- max. recess depth 163 mm
  - min. recess depth 90 mm



30 010 662

mm [inches]

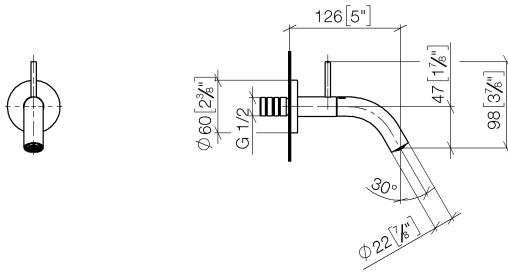

**Flow rate chart**



**Certificates**

LGA\_38414.

30 010 662

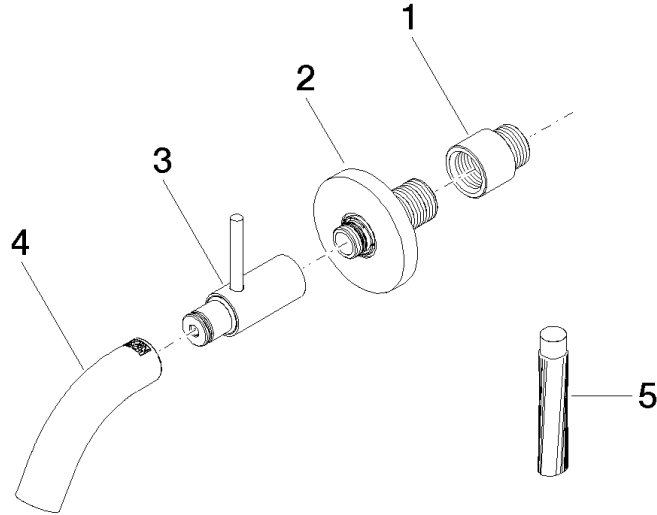

**Spare parts list**

No.	Item Number	Name	Quantity used	Delivery time
1	09 24 03 072 10 90	nipple	1	2
2	90 27 66 019 00-00	rosette	1	10
3	90 20 66 023 00-00	handle	1	10
4	90 28 22 385 00-00	spout	1	10
5	09 16 03 001 90	grease	1	2